

**IVECO**

Drive the road of change



Your new S-WAY of life.

**IVECO**  **S-WAY**

# Get used to your new S-WAY of life.

IVECO S-WAY is the perfect travel companion for the driver, the ideal business solution for the fleet owner and the sustainable friend of the environment.

IVECO S-WAY raises the driver's working and living experience to a new level with the cab designed around their needs providing a spacious and well laid out environment rich in comfort features, advanced functionalities and the new IVECO DRIVER PAL voice companion.

A true fuel efficiency and Total Cost of Ownership performer, IVECO S-WAY delivers outstanding value and productivity for the fleet owner with its advanced technologies and innovative services tailored to their needs.

With its focus on sustainability, IVECO S-WAY strides forward on the path to decarbonization, already approaching 2025 targets, by introducing product features that reduce its CO<sub>2</sub> emissions.

IVECO S-WAY is the smart intelligence evolution: a 100% connected truck that ushers in a new era of proactive and predictive support, featuring the new IVECO DRIVER PAL that turns the vehicle into the perfect travel companion for a better and safer driving experience!







06	Style meets performance...	30	The new sustainability performer
08	... functionality meets comfort	33	IVECO S-WAY Natural Gas rigid at a glance
10	New IVECO DRIVER PAL	36	Tank combinations for every mission and the longest distances
12	Distinctive and functional	38	IVECO ON
14	Premium driving comfort	42	IVECO TOPCARE
16	Everything in its place	44	Meet IVECO DRIVER PAL your vocal companion
18	Rest, relax and sleep well	46	ELEMENTS
21	Lit to perfection	48	IVECO Accessories
22	The right cab for every mission	49	IVECO Services
26	Rigid versatility	50	Choose your preferred IVECO S-WAY model
28	The natural way		

# Style meets performance...

Every single detail has been carefully studied to maximise the vehicle's aerodynamic performance: all the spaces and gaps have been closed to optimise the air flow and provide a significant boost to fuel efficiency. Under the hood, the new engine line up and components raise the bar on performance and fuel efficiency, giving a boost to your business productivity.



## ALL VERSIONS

- 1 OPTIMISED MIRROR DESIGN
- 2 REDESIGNED DOOR AND EXTENSION
- 3 NEXT GENERATION REAR AXLE RATIOS UP TO 2.31
- 4 AERODYNAMIC KIT
- 5 HIGH EFFICIENCY A-PILLAR COVER
- 6 FRONT CORNER FINS
- 7 RESHAPED ROOF
- 8 4G CONNECTIVITY BOX
- 9 13.5% CX COEFFICIENT IMPROVEMENT
- 10 FRONT GRILL DESIGN
- 11 INTEGRATED PARKING COOLER
- 12 CLUTCH COMPRESSOR AND VARIABLE-FLOW STEERING PUMP
- 13 FOLDABLE STEP
- 14 MULTI-PIECE BUMPER WITH SIDE DEFLECTORS

## DIESEL VERSION

- 15 SIDE SKIRTS
- 16 NEW C13 ENGINE LINE UP
- 17 ENGINE IMPROVEMENT WITH INCREASED COMPRESSION RATIO

## NATURAL GAS VERSION

- 18 BEST-IN-CLASS FUEL AUTONOMY (UP TO 1600 km WITH LNG)
- 19 LATEST GENERATION LNG TANKS
- 20 SILENT MODE: 71 DECIBELS



... **functionality**  
meets **comfort.**

- CHOICE OF UPPER BUNKS
- CENTRAL BED MODULE
- SYMMETRIC BED ZONE CONCEPT
- MULTIPLE FRIDGE COMBINATIONS
- CONVENIENT WALL POCKETS





**EASY-TO-REACH  
ROOF POCKETS**

**NEW IVECO  
DRIVER PAL**

**CHOICE OF SEAT  
UPHOLSTERY  
AND FEATURES**

**MORE SPACE FOR  
THE DRIVER**

**MULTI-FUNCTIONAL  
STEERING WHEEL**

**ELECTRONIC KEY  
SLOT AND ENGINE  
START/STOP BUTTON**

**FULL LED INTERIOR  
LIGHTING**

**BIGGER ROOF HATCH**

**COMFORTABLE 2.15 m  
STANDING HEIGHT**

**SHAPED HIGH-CAPACITY  
UPPER SHELF**

**LOWER CENTRAL  
CONSOLE AND  
REDESIGNED  
CENTRAL STACK**

**SWIVELLING  
CO-DRIVER SEAT**

IVECO 

IVECO  
DRIVER  
PAL 

just ask | alexa 

# New IVECO DRIVER PAL.

IVECO DRIVER PAL takes the driver's life on board to the next level, turning their vehicle into the perfect travel companion.

"Alexa, open MYIVECO"

"Alexa, ask MYIVECO where is my vehicle"

"Alexa, what's the weather today?"

"Alexa, ask MYIVECO which is the level of the fuel"

"Alexa, ask MYIVECO to look for a restaurant to stop"

"Alexa, ask MYCOMMUNITY what are my messages"



## **COMFORT**

In their smart cab, with Alexa fully integrated into the vehicle, drivers can interact with their truck and operate all in-cab controls simply using their voice.

## **SAFETY**

With their voice companion, drivers enjoy a safer driving experience with fewer distractions, taking care of secondary tasks using their voice so they can remain focused on the mission.

## **PRODUCTIVITY**

With the new, innovative voice service, drivers can vocally manage their route planning, check their vehicle's health status, ask for help to avoid unplanned stops and delays with information about traffic jams, weather conditions and other disruptions.

## **COMMUNITY**

With IVECO DRIVER PAL, drivers are connected with the driver community. They can safely communicate with other drivers, share information and advice on their route – and language is no barrier, because their IVECO vocal companion translates for them.

# Distinctive and functional.

## The all-new bumper.

The redesigned bumper offers a choice of plastic and hybrid solutions to match the requirements of your specific mission. The multi-piece bumper will protect you and your vehicle – and save on repair costs as you only need to replace the damaged section.

You can personalize the bumper and side skirts with a choice of colour and material combinations. Rubber extensions on the side skirts contribute to the excellent aerodynamics and efficiency of the design.

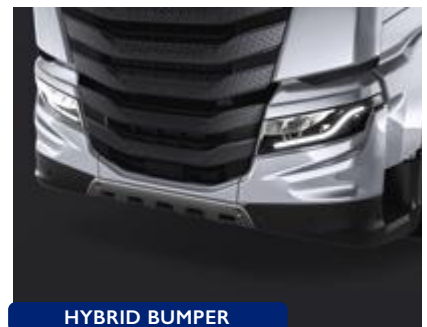
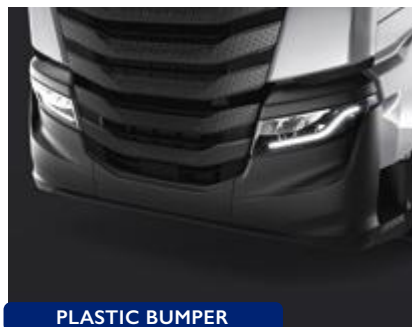



**HIGH BEAM**

**LOW BEAM**

**FOG LIGHT  
(CORNERING  
AND BENDING  
FUNCTIONS)**

**GUIDE – DRL  
AND TURN  
INDICATOR**

## **Full led** headlights.

The new-design full led headlights will ensure you have all the visibility you need. The twilight sensor on the windscreen automatically turns on the low beam in low-light conditions. Cornering and bending functions improve the driver's visibility when turning.

# Premium driving comfort.

The entire driver area has been created to provide more space and excellent visibility. Every single detail has been carefully studied to meet the driver's expectations on the road.



## STEERING WHEEL

All the vehicle's key functions at your fingertips

## KEY LOCK AREA

Turn the engine on and off by simply pushing the Start/Stop button

## INTEGRATED HVAC SYSTEM

Heating, ventilation and air conditioning with "Eco mode" function



Customize your seats with leather or fabric upholstery and enjoy the luxurious comfort of the cushions

## INFOTAINMENT

Bring your digital life on board with smartphone mirroring and innovative features

## TWILIGHT & RAIN SENSOR

Automatically turns on the headlights and windscreen wipers

## LOWER CONSOLE

Handy shelf with bottle and cup holders and background lighting



Choose the soft touch or leather steering wheel, both available in the classic shape or with the distinctive flat base

Everything  
in its place.







1



2



3



4

The spacious new cab offers all the storage you need, with well laid-out capacious compartments. The shaped upper shelf has a massive capacity of 250 litres.

- 1 The outer compartments offer a massive storage capacity of up to 380 litres
- 2 The lower console can contain a thick A4 folder
- 3 Wide selection of refrigerators with capacities up to 100 litres and available with freezer
- 4 The new open glove compartment includes a 1.5-litre bottle holder

**Rest, relax  
and sleep well.**





The symmetrical layout of the night area has been designed so you can enjoy a good night's rest in great comfort.  
The one-piece lower bunk offers a choice of soft or hard mattress.

- 1** Choose from the Smart or Comfort upper bunk, which can be used as a luggage compartment or a passenger bed
- 2** You can sleep safe with the central locking system integrated with the night-time safety lock
- 3** The rotary switch controls the light selection and dimming
- 4** You can control all the functions you need, such as lighting, heating, radio or doors, from the bed module and on the IVECO ON Easy Way App
- 5** Two USB ports are located on the upper pockets of each wall





# Lit to perfection.

The IVECO S-WAY is 100% full led – inside and out, including the clearance lights. The new led lights provide the perfect illumination inside the cab and on the road for safe night-time driving.



# The right cab for every mission.



The IVECO S-WAY cab line up offers a choice of cabs to match your mission: the AS sleeper cab, the AT sleeper cab with low or medium roof, and the AD short cab with low roof.

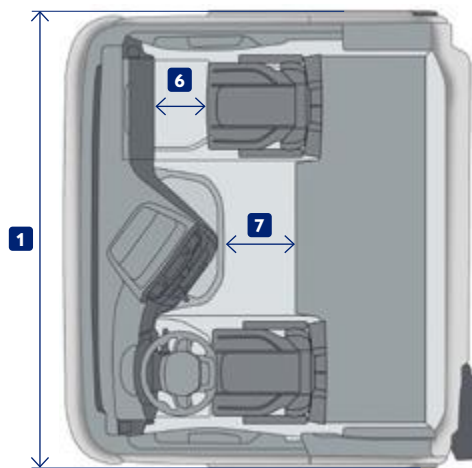
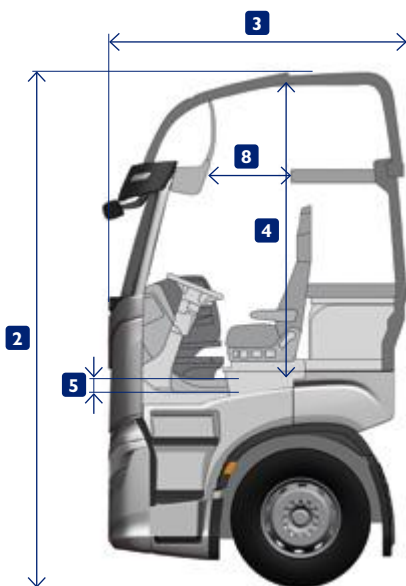

## LEGEND

- 1** WIDTH
- 2** OVERALL HEIGHT
- 3** LENGTH
- 4** FLOOR TO ROOF CAB CENTRE
- 5** TUNNEL HEIGHT
- 6** PASSENGER USABLE SPACE
- 7** LOWER USABLE SPACE
- 8** UPPER USABLE SPACE



		1	2	3	4	5	6	7	8		
	Roof	Width (mm)	Overall height (mm)	Length (mm)	Floor to roof cab centre (mm)	Tunnel height (mm)	Passenger usable space (mm)	Lower usable space (mm)	Upper usable space (mm)	Bunk <sup>(2)</sup>	Boarding Steps
AS	High	2500	3800 <sup>(1)</sup>	2250	2150	95	430	500	785	1 (2)	3
	Low	2500	3300 <sup>(1)</sup>	2250	1700	95	430	500	–	1	
AT	Medium	2300	3550 <sup>(1)</sup>	2150	1850	340	370	470	480	1 (2)	3
	Low	2300	2900 <sup>(1)</sup>	2150	1250	340	370	470	–	1	
AD	Low	2300	2900 <sup>(1)</sup>	1700	1250	340	370	–	–	0	3

Dimensions can vary according to the model

**Note**

<sup>(1)</sup> Approximate measures; may change based on suspensions, assembly variables and approximations

<sup>(2)</sup> Upper bed as option

**AS Cab**

Lower bunk length 2100 mm, width 800 mm (700 mm rear seats), upper bunk length 2040 mm, width 600 mm (700 mm with comfort bunk)

**AT Cab**

Lower bunk length 1950 mm, width 540 mm, upper bunk length 1850 mm, width 680 mm

## The new fuel efficiency performer.

IVECOS-WAY raises the bar on performance and fuel efficiency, introducing a new engine line-up and fuel efficiency features. The engine line-up, extended with the 490-hp and 530-hp Cursor 13 engines, together with the next-generation rear axle, the improvement in engine performance through an increased compression ratio, the better aerodynamics achieved with the high-efficiency A-pillar cover and the new auto a/c system “Eco mode” function, deliver up to 3% fuel efficiency. The resulting boost on business productivity makes the IVECO S-WAY the ideal business solution for the fleet owner and the best fuel efficiency performer for long-haul missions.

In addition, rear axle ratio 2.31 are now available in combination with standard profile tyres. This allows substantial down-speeding and therefore more efficiency when cruising on long-distance routes.





# High-efficiency engines.

The IVECO S-WAY offers a wide choice of Euro VI diesel engines to suit all applications. The diesel engines, with 3 displacements and power ratings ranging from 340 to 570, deliver class-leading power. The Cursor diesel engine EVI family is fully compatible with 2<sup>nd</sup> generation biofuels HVO / XTL (EN 15940).

**DIESEL ENGINE LINE-UP**

Engine	Displacement (litres)	Power		Torque		Turbo	Cab type		
		hp	kW	rpm	Nm		rpm	AS	AT/AD
Cursor 9	8.7	340	251	1710 – 2200	1400	1100 – 1710	WG	–	•
		360	265	1530 – 2200	1650	1200 – 1530	WG	–	•
		400	294	1655 – 2200	1700	1200 – 1655	eVGT	–	•
Cursor 11	11.1	420	309	1475 – 1900	2000	870 – 1475	eVGT	•	•
		460	338	1500 – 1900	2150	925 – 1500	eVGT	•	•
		480	353	1465 – 1900	2300	970 – 1465	eVGT	–	•
Cursor 13	12.9	490	357	1700 – 1900	2400	950 – 1100	eVGT	•	–
		530	387	1600 – 1900	2400	950 – 1500	eVGT	•	–
		570	419	1605 – 1900	2500	1000 – 1605	eVGT	•	–

New horse power



Cursor 9



Cursor 11



Cursor 13

# Fuel-saving devices.

- The Anti-idling feature avoids long periods of idling, automatically shutting off the engine.
- Smart Engine Auxiliaries prevent energy waste when their operation is not necessary:
  - Air Clutch Compressor
  - Smart Alternator
  - Variable Steering Pump
- IVECO ECO MODE PLUS & ECO FLEET for maximum fuel efficiency.
- The IVECO HI-CRUISE GPS predictive driving system integrates driving assistance functions such as eco-roll, predictive gear shifting and predictive cruise control using state-of-the-art GPS mapping technology.
- The 12-speed HI-TRONIX automated transmission with electronic clutch offers the most advanced technology in its category, best-in-class torque-to-weight ratio and long transmission oil change intervals.

# Rigid versatility.

The IVECO S-WAY offers a full range of rigids, in diesel and Natural Gas versions, suitable for all missions – from municipal applications and deliveries to swap body. The robust and durable chassis makes it a favourite of bodybuilders for the ease and wide variety of possible builds.





# The natural way.

The IVECO S-WAY is powered by the most mature Natural Gas technology on the market. It delivers a highly efficient performance while maximising the advantages of the most environmentally-friendly fuel available today, efficiency without compromise.



## **IVECO's roadmap** to decarbonization.

IVECO takes a stride forward on the roadmap to decarbonization with the introduction of new product features on the CNG and LNG versions that further slash CO<sub>2</sub> emissions and improve fuel efficiency, making 2<sup>nd</sup> the IVECO S-WAY a sustainable friend of the environment and a sustainable leader in long-haul transport.

## **Efficient environmental** sustainability.

The IVECO S-WAY Natural Gas maximises the advantages of the most environmentally friendly fuel to improve air quality with less Particulate Matter and less NO<sub>2</sub>, and mitigate climate change by reducing CO<sub>2</sub> by 95% with biomethane. It also contributes to a quieter environment with just 71-72 dB(A) Piek Quiet Truck when running in Silent mode – ideal for night-time deliveries.



**-95%**  
CO<sub>2</sub> emissions

## **Circular** economy.

The IVECO S-WAY Natural Gas can run on biomethane, a renewable energy that delivers the lowest carbon footprint based on Life Cycle Analysis. It can be produced locally from agricultural and urban waste, creating additional revenues for farmers and local jobs. It also means the possibility of a circular economy that minimises the use of new resources, the creation of waste, and carbon emissions – it can even achieve negative Greenhouse Gas emissions and carbon sequestration.

## **Expert support from** the technology leader.

IVECO has pioneered Natural Gas technology for more than 20 years, developing a widespread network of IVECO service points specialised in LNG and CNG technology, which provide support across Europe.

# The new sustainability performer.



## Naturally long-distance.

The IVECO S-WAY Natural Gas is the first Natural Gas-fuelled truck in the market specifically designed for international long-haul transport with exceptional autonomy of up to 1600 km in the LNG version.

It offers transporters the competitive advantage of a truly green and profitable solution with best-in-class Total cost of Ownership.

The IVECO S-WAY CNG and LNG versions introduce new smart auxiliaries, such as clutch compressor and variable-flow steering pump. These features, in combination with the next-generation rear axle, the auto a/c system “Eco mode” function and the high efficiency A-pillar cover, deliver a further reduction in CO<sub>2</sub> emissions, making the IVECO S-WAY Natural Gas the best sustainability performer.

## Naturally powerful.

The IVECO S-WAY offers a wide choice of Natural Gas engines that deliver clean running and quiet operation to suit all applications.

The Cursor 9 engine was designed for a wide range of missions: from urban to regional distribution, garbage collection and construction logistics. The optimised stoichiometric combustion process and weight of the 8.7-litre displacement engine deliver the best fuel efficiency in all conditions. The Cursor 13 engine, with a 12.9-litre displacement, enhanced combustion process and optimised weight, delivers the best fuel efficiency even in very long-distance missions.

NATURAL GAS ENGINE LINE-UP

Engine	Displacement (litres)	Power		Torque		Turbo	Cab type		
		hp	kW	rpm	Nm		rpm	AS	AT/AD
Cursor 9 NP	8.7	340	251	1600 – 2000	1500	1100 – 1600	WG	–	•
		400	294	1575 – 2000	1700	1200 – 1575	WG	–	•
Cursor 13 NP	12.9	460	338	1620 – 1900	2000	1100 – 1620	WG	•	–



Cursor 9 NP



Cursor 13 NP

## The longest service intervals.

Oil change intervals have been extended even further to 90,000 km and the Cursor 13 specific gas components have been modified to minimise maintenance costs and maximise uptime.

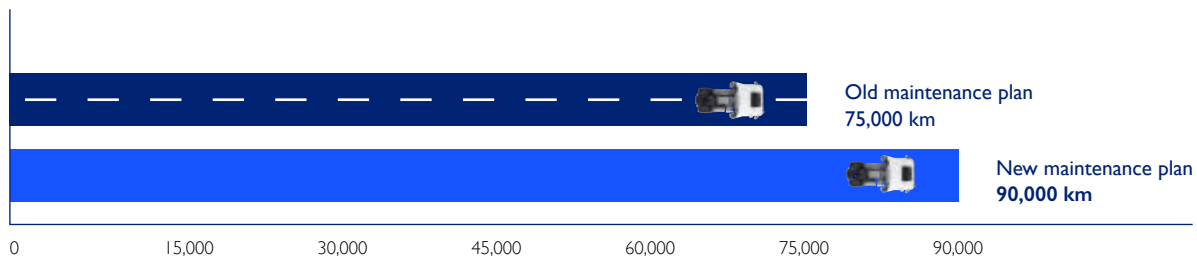

## Simple maintenance-free after-treatment system.

The longitudinal, compact and lightweight 3-way catalyst contributes to compliance with the most stringent emissions standards while ensuring low noise levels. This system requires no additives, particulate filter or parked regeneration, so that it needs little maintenance. Its compact size and inside-frame installation leaves plenty of space for bigger fuel tank capacity and auxiliary installations such as a cooling group, cryogenic tanks or a storage box.

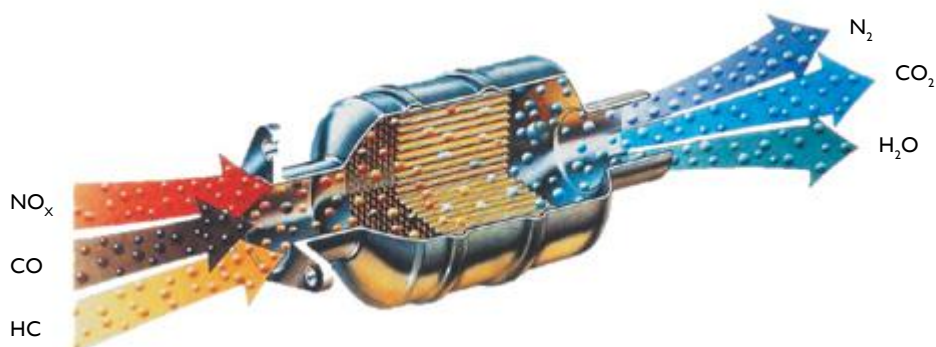

### **3-WAY CATALYST: A LIGHT AND SIMPLE AFTER-TREATMENT SYSTEM**

**NO ADBLUE®**

**NO MAINTENANCE**

**NO PARTICULATE FILTER**

**NO PARKED REGENERATION**



# IVECO S-WAY

## Natural Gas rigid at a glance.

The IVECO S-WAY Natural Gas 2- and 3-axle rigid has been designed to provide a truly sustainable transport solution for urban and regional distribution, refrigerated transport, waste transport and urban construction missions such as concrete transport, material and vehicle handling or tipper missions.

- 1** SILENT MODE: 71 DECIBELS
- 2** WIDE OFFERING OF TRANSMISSION AND ENGINE PTO  
12-SPEED AUTOMATED TRANSMISSION OR AUTOMATIC  
CURSOR 9 AND 13 NATURAL GAS ENGINES
- 3** LONGITUDINAL IN-FRAME 3-WAY CATALYST
- 4** BEST-IN-CLASS FUEL AUTONOMY (UP TO 1600 km WITH LNG, UP TO 1000 km WITH CNG)  
CUSTOMISABLE CNG AND LNG TANK LAYOUT
- 5** CONSTANT SECTION CHASSIS RAILS  
PNEUMATIC OR FULL PNEUMATIC SUSPENSION
- 6** TOWING MODELS UP TO 50 TONS GCW CAPABILITY



## Access all areas.

The IVECO S-WAY Natural Gas rigid provides the ideal solution to deliver logistics services that address the increasingly critical issue of pollution in city centres and high traffic transport routes. Thanks to its quiet operation, with just 71 dB(A) Piek Quiet Truck when running in Silent mode, and ultra-low NO<sub>2</sub> and PM emissions, the IVECO S-WAY CNG/LNG can access city centres, densely populated areas and high traffic motorways with the strictest emissions restrictions – and it can operate round the clock.

When running on biomethane, it is the most efficient way of delivering fossil-free and CO<sub>2</sub>-free transport here and now.

The energy transition is happening, as cities and local authorities address the issue of air quality and greenhouse gas emissions, and IVECO is at the forefront of it with our full offering of Natural Gas vehicles.



## The reference for refrigerated transport.

The IVECO S-WAY Natural Gas has been designed to host all the new diesel-free cooling technologies available on the market to provide a carbon-neutral solution when running with biomethane.



# Tank combinations for every mission and the longest distances.

## Maximum tank flexibility.

You can choose from a wide offering of tanks of varying types, shapes and sizes which can be combined to meet the requirements of your mission.



- 1** LNG tank on the right side, available in combination with, on the left side:
- LNG
  - CNG
  - Free

- 2** CNG tanks on the right side, available in combination with, on the left side:
- LNG
  - CNG
  - Free

- 3** CNG tanks behind the cab, available in combination with:
- Left side CNG; right side CNG
  - Left side CNG; right side free
  - Left side free; right side CNG

- 4** LNG tank on the left side, available in combination with LNG tank on the right side.

- 5** CNG tanks on the left side, available in combination with CNG or LNG tanks on the right side.

- 6** CNG tanks on the chassis, available in combination with:
- Right side CNG; left side free
  - Right side free, left side CNG
  - Right side CNG, left side CNG



## Best-in-class fuel autonomy.

LNG tanks for standard tractors come in 4 sizes to free up the space you need on the chassis for your mission. The IVECO S-WAY offers all the safety and ergonomics benefits of the latest generation LNG tanks.



LNG – up to 1600 km



LNG – up to 1400 km

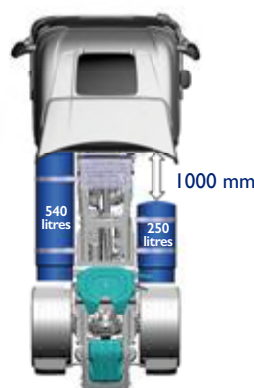

LNG – up to 1150 km



LNG – up to 800 km



# is the new world of integrated services and transport solutions.

## A clear benefit to our customers.

IVECO is "ON" your side, delivering real benefits for your business with the advantages of the service offer you chose:



To manage your fleet by monitoring your vehicles' fuel consumption and drivers, as well as planning their missions, optimising routes and dispatching orders



To keep your vehicle always on the road, anticipating and avoiding unforeseen breakdowns. Our roadside assistance will always be with you



Specific vehicle monitoring and reporting, and the assistance of your IVECO DRIVER PAL voice companion will leave you free to focus entirely on your work with no worries knowing that we will take care of you, your driver and your vehicles while on the road



For specialised assistance when you choose from our offer of tailored service contracts



To complete the IVECO ON offer by choosing original IVECO Parts and Accessories



**Created by IVECO to help you make your business more competitive, profitable, sustainable and easier to manage**

It provides a flexible offer that can be customised to match your business requirements and missions: from connected services to boost your vehicle's potential to a complete set of tailored aftermarket solutions to be at your side in every moment of your journey!

**Discover the world of new services that come with the new IVECO WAY range!**

**Save money, improve your performance and simplify your work** by choosing our connectivity and selecting the solution that is the best match to your requirements.

Find out more about the **commercial packages** you can choose your services from.



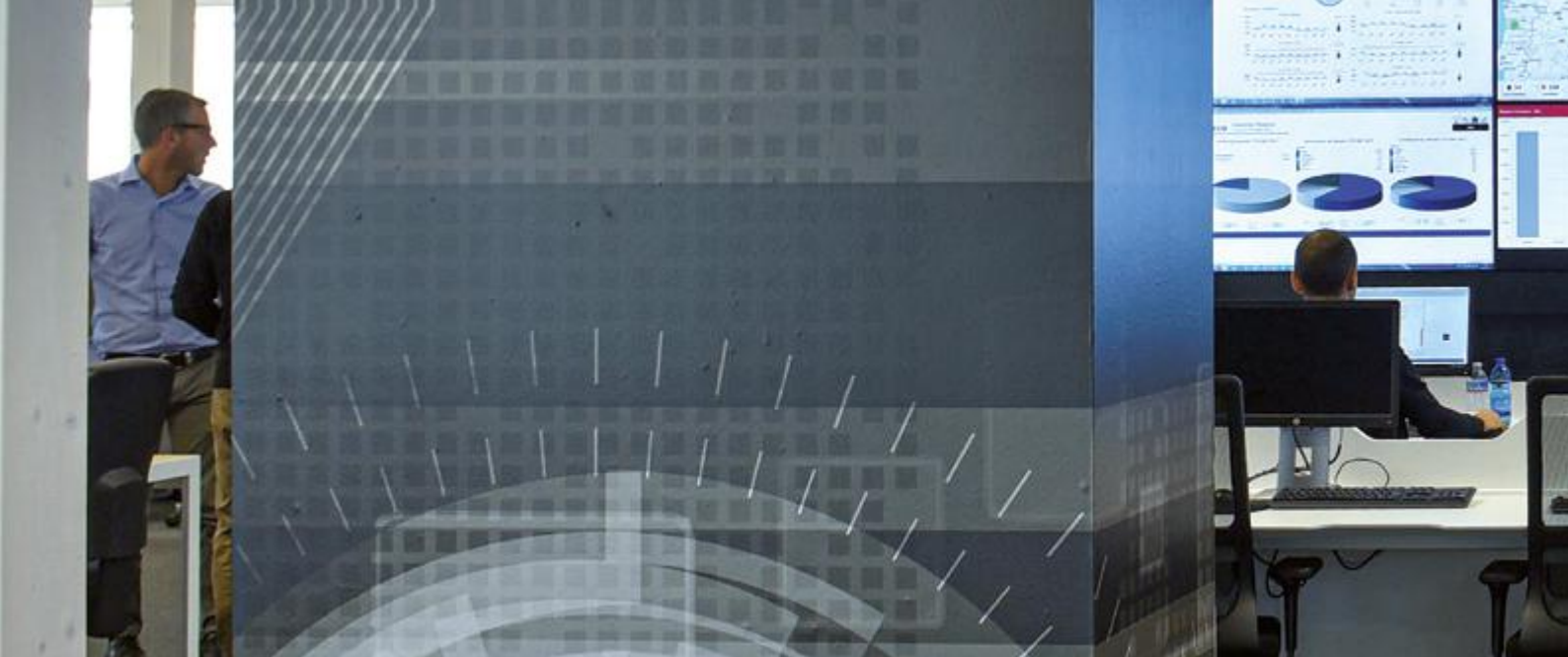

## Smart Pack.

The Smart Pack, always included in all IVECO WAY range vehicles, offers the benefits of IVECO ON CARE and IVECO ON UPTIME provided with the following services.

### Smart Report

The Driving Style Evaluation (DSE) algorithm generates weekly reports on the vehicle's and driver's performance with tips on how you can improve the driving style for fuel and vehicle optimisation.

### Safe Driving Report

Together with the Smart Report and thanks to the Driving Style Evaluation, you will now receive this new report that will allow you to measure your safety on board.

### IVECO ON customer portal and App

They enable you to monitor your vehicle's fuel consumption and your driver's driving style in a dynamic way, so you can identify how to optimise your fleet's performance. You can also plan and book service appointments efficiently to maximise uptime.

### Vehicle monitoring and remote assistance

The remote diagnostics tool, the teleservices and the over-the-air software updates will grant you a proactive approach and maximised vehicle's uptime, anticipating possible faults and downtime.

### The IVECO ON Easy Way App is designed to make your life easier

Manage the cabin and vehicle functionalities directly from your mobile device: driving style evaluation, remote assistance service and over the air update, cabin control all at hand. Now with IVECO DRIVER PAL integration to easily activate MYIVECO and MYCOMMUNITY Skills. Push notifications to keep you informed about the vehicle's health and a new QR code to pair your mobile device to your vehicle.



Cabin Control



IVECO Assistance Non-Stop



Driving Assist



Remote Assistance Service







## Premium Pack.

The Premium Pack offers all the services included in the Smart Pack, plus the full benefits of IVECO ON CARE, UPTIME, FLEET and M&R. It guarantees follow-up on the data provided by your vehicle, by putting you in contact with IVECO experts who will advise you on the best way to use it. You can choose the modular options you wish to add to your package.

### Professional fuel advising

IVECO TCO Advisor will provide you with periodic consultancy and advice on how to reduce fuel consumption, maximising your use of the truck.

### Flexible maintenance\*

The real-time data provided by your vehicle through its connectivity enables you to plan maintenance interventions efficiently, to reduce unplanned stops and maximise the life of the monitored components based on the real usage of the vehicle.

### IVECO TOPCARE\*\*

As a Premium Customer, IVECO provides you with an extra care solution, to repair your vehicle within 6 hours. You get the priority you deserve. If the vehicle is not back on the road within 6 hours, IVECO will offer you a hospitality package that includes accommodation, transport and medical assistance if you need it.

(See the following page for more details)

### Fleet management

It helps you monitor your vehicles' fuel consumption and drivers, plan their daily activities, optimise routes and dispatch orders. Increase your fleet administration capabilities through insights on driver's workdays and geolocation.

### IVECO web API

The Application Program Interface allows flexible data integration in your own systems and facilitates the management of IVECO-generated data together with that of other brands' vehicles in a single tool.

### Professional Safe Driving Report

Based on the results you will receive with the Safe Driving Report, our TCO Advisor will contact you in order to advise you on how to be safer on the road.

\* Available only on Artic Diesel version

\*\* Available only on Artic version

# IVECO TOPCARE.

**Our premium service**  
for your peace of mind.



IVECO TOPCARE is a Premium assistance service designed to ensure your vehicle is quickly back on the road and to care for you in the event of more severe failures. Through our network of around 1800 IVECO authorized workshops across Europe, our trained diagnostic experts are ready to assist you 24/7.



### **Geofencing**

In the event of an unexpected stop or breakdown, the IVECO Control Room operators, who play a key role in supporting our telematics services, automatically receive an immediate alert that you are in one of our 1800 workshops, thanks to the geofencing system.



### **Fast track & repair**

You will automatically have the highest priority in resolving your fault, so you can count on increased uptime and you will receive regular updates on the status of the repair.\*



### **Hospitality services**

If repair takes longer than expected, and you are far from home, we will take care of you, providing you with comfort and rest, thanks to a set of hospitality services including transfer, meals, hotel and medical assistance in case of need.



\* This additional coverage is available on Heavy trucks with connectivity box and connectivity disclaimer signed and it is linked to Elements 2XL and 3XL M&R packages for 3 years

# Meet IVECO DRIVER PAL

your vocal  
companion.

IVECO ON

IVECO  
DRIVER  
PAL



With IVECO DRIVER PAL, drivers can bring their digital life on board, interact vocally with their vehicle and the driving community and access IVECO's connected services through Amazon Alexa voice commands. They can enjoy a better driving experience, keeping their hands on the steering wheel and their eyes on the road!\*

## New features for an even better experience

The enhanced "Open MYIVECO" vocal request helps the driver navigate the most frequently used commands and stays open for a natural and fast interaction.



You can use the skills throughout the day – while you drive, when you are resting in the cab, or when you are at home, through a Alexa-enabled device or the dedicated App.

"Alexa, ask MYIVECO  
to switch on ambience lights"



"Alexa, ask MYIVECO  
to set the heater to 20 °C"



\* Activate the IVECO DRIVER PAL Skills directly from the IVECO ON Easy Way App, just follow the steps on the tutorial. It is easy!

IVECO has developed two unique skills, MYCOMMUNITY and MYIVECO, with Amazon Alexa features, in collaboration with Amazon Web Services Professional Services and Alexa Auto team to help you work more comfortably and safely.

Try the innovative IVECO Skills dedicated to the driver's life on board and at home.\*

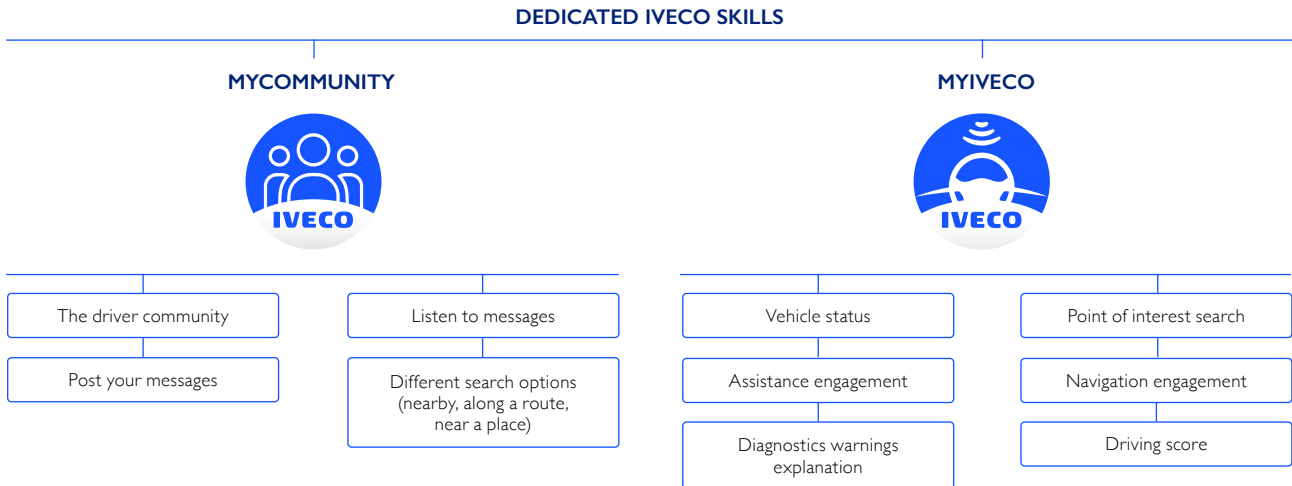

## MYCOMMUNITY Skill.

### Interact with the driver community

The exclusive MYCOMMUNITY Skill enables you to rely on the support of the driver community. You can exchange information on queues or traffic jams, tips on the best rest stops on your route – and language is no barrier, as messages are translated automatically.

MYCOMMUNITY App is free and available to all drivers.

## MYIVECO Skill.

### Enjoy the exclusive connected collaboration of IVECO DRIVER PAL

IVECO DRIVER PAL, coupled with the Connectivity Box, allows you to check battery charge, tyre pressure, fluids levels, as well as set a destination on the navigation system or book a service stop at the nearest IVECO workshop. You will enjoy a truly collaborative relationship with your vehicle!

\* Amazon, Alexa and all related marks are trademarks of Amazon.com, Inc. or its affiliates

# ELEMENTS.

Pick the services that perfectly match your business.

The IVECO S-WAY offers an extensive range of services that can be tailored to your precise requirements to keep your vehicle running in top form and your business operating with a healthy bottom line.

The IVECO S-WAY introduces an entirely new level of customisation through connectivity. The real-time vehicle data it provides enables us to offer you **bespoke maintenance plans** based on the real use of your IVECO S-WAY – a perfect match to your business.

Alternatively, our **ELEMENTS** range offers the extreme **flexibility** that enables you to choose the combination of Planned Maintenance and Extended Warranty services for your business, and further enrich your package with the Additional Coverage elements.



## MAINTENANCE



- Maintenance
- Lubrication
- Oil and fluid changes according to the maintenance and repair handbook

## DRIVE LINE



- Engine
- Fuel injection
- Gearbox
- Propeller shaft and axle repairs

## EXTRA DRIVE LINE



- Components not already covered by the drive line element  
e.g. Electrical System

## WEAR



- Clutch
- Brake pads
- Brake discs
- Brake drums
- Brake linings for drum brakes





The major “elements” making up the offer (maintenance, drive line, extra drive line, wear) can be combined in order to create the contract that perfectly suits your business. The table below summarises all the possible combinations:

**PLANNED MAINTENANCE CONTRACTS**

	Maintenance	Drive line	Extra drive line	Wear
 3XL LIFE	•	•	•	•
 2XL LIFE	•	•	•	
 XL LIFE	•	•		•
 L LIFE	•	•		
 M LIFE	•			•
 S LIFE	•			

**EXTENDED WARRANTY**

	Drive line	Extra drive line
 XTRA XTENDED LIFE	•	•
 XTENDED LIFE	•	

 Try the flexible maintenance in order to maximise your maintenance interval with us

For inclusions / exclusions please refer to contractual documents relevant to your Market

The truck is much more than a vehicle: it is where thousands of people live and work every day. That's why IVECO Accessories created a range of tailor-made product to satisfy the driver's needs, improve their performance, enhance the vehicle's style and comfort, and introduce new technologies on board.



## Express your personality

New IVECO S-WAY can be made even more exclusive with the new styling kit, mirror covers and chromed details – like the new lightbar and the chromed styling kit of the vehicle.

### 1 TECHNOLOGY ON BOARD

Bring the most updated technologies on board and enjoy your comfort. The new subwoofer system enhances sound quality and the new 22" TV allows you to relax at the end of a day behind the wheel. Install the new tailor-made cradle for smartphone and tablet on the dashboard: your device will be within easy reach and you will always be connected

### 2 TECHNOLOGY TO STAND OUT

Stand out from the crowd with the unique front light kit that gives your vehicle an aggressive and futuristic style. Choose from millions of colour shades to personalise the lights with the fibre-optic grid and App. Together with the backlit IVECO logo, it will give your vehicle an unmistakable look



**IVECO Genuine Parts** represent the best guarantee of **safeguarding the value of new IVECO S-WAY** over time, **protecting from unplanned downtime**, ensuring safety for people and goods. IVECO also offers the widest range of new and remanufactured components, servicing kits and telematics solutions, suitable for every stage of the new IVECO S-WAY's lifecycle. IVECO operates a network of 6 parts depots across Europe, covering over 335,000 sqm, managing 400,000 part numbers and guaranteeing 24/7 parts delivery.



**IVECO**  
**0080048326000**  
**Assistance Non-Stop**



The **IVECO Assistance Non-Stop** answers 24 hours a day, 7 days a week, providing assistance in 36 European countries to help Customers keep their vehicles on the road. In case of breakdown it can be reached through a phone call, using the IVECO Non-Stop App, using the telematic system on board.

The **IVECO Non-Stop App** can also be used to book in advance a repair work for your vehicle, not just in case of urgency. You can select the time window and the location and the App will give you a confirmation of the booking.

## **IVECO CAPITAL**







**IVECO CAPITAL** is the captive financial services Brand of IVECO, and offers a full range of financing, leasing, rental and ancillary services for commercial vehicles. Extended warranty, maintenance and repair services, and various types of insurance, can be included in the pack\*. All financial packs can be tailored to the Customer's needs, and apply to new, used vehicles and conversions. For more information, please contact your IVECO Dealer.



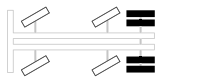
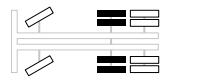

\* Subject to credit approval. Offerings and products may vary by country depending on the local fiscal and accounting regulations

# Choose your preferred IVECO S-WAY model.





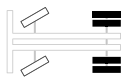
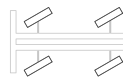

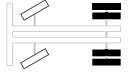
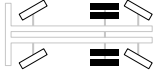
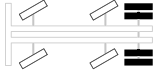

## ARTIC

		4x2	6x2C	6x2P (Twin)
IVECO S-WAY				
Cab roof	AS	- 	- 	
	AT	 -	 -	-
	AD	 -	- -	-
Engine / Gearbox	Cursor 9	Automated -	- -	-
	Cursor 11	Automated / Manual Automated	Automated Automated	Automated
	Cursor 13	- Automated	- Automated	Automated
Rear axle suspension	SR	Pneumatic / Full Pneumatic	Pneumatic / Full Pneumatic	Pneumatic / Full Pneumatic
Wheelbases (mm)		3.650 – 3.800	3.800 – 4.000	3.200





## ARTIC

		4x2	6x2C
IVECO S-WAY Natural Gas			
Cab roof	AS		
	AT	-	-
	AD	-	-
Engine / Gearbox	Cursor 9	-	-
	Cursor 13	Automated	Automated
Fuel system	CNG	Up to 650 km	-
	LNG	Up to 1600 km	Up to 750 km
Rear axle suspension	SR	Pneumatic / Full Pneumatic	Pneumatic / Full Pneumatic
Wheelbases (mm)		3800	4000

RIGID

		4x2	6x2P	6x2C
IVECO S-WAY				
Cab roof	AS	- 	- 	-
	AT	 -	 -	
	AD	 -	 -	
Engine / Gearbox	Cursor 9	Automated / Automatic -	Automated / Automatic -	Automated / Automatic
	Cursor 11	Automated / Manual Automated	Automated / Manual Automated	-
	Cursor 13	- Automated	- Automated	-
Rear axle suspension	SR	Pneumatic / Full Pneumatic	Pneumatic / Full Pneumatic	Pneumatic / Full Pneumatic
Wheelbases (mm)		3800 – 6700	3120 – 6050	4200 – 4500

RIGID

		4x2	6x2P	6x2C
IVECO S-WAY Natural Gas				
Cab roof	AS	- 	- 	-
	AT	 -	 -	-
	AD	 -	 -	
Engine / Gearbox	Cursor 9	Automated / Automatic -	Automated / Automatic -	Automatic
	Cursor 13	- Automated	- Automated	-
Fuel system	CNG	Up to 1000 km		150 – 400 km
	LNG	Up to 1600 km		-
Rear axle suspension	SR	Pneumatic / Full Pneumatic	Pneumatic / Full Pneumatic	Full pneumatic
Wheelbases (mm)		3800 – 6300 /FP CM: 5700	3120 – 6050 4200 – 6050	5000



PUBLICATION H2227801MASTER - 09/22

The information and images in this catalogue are provided as a guideline only. IVECO reserves the right to make changes for any commercial or construction reasons at any time without notice.